

# HLMP-132x Series, HLMP-142x Series, HLMP-152x Series



T-1 (3 mm) High Intensity LED Lamps

## Data Sheet



### Description

This family of T-1 lamps is specially designed for applications requiring higher on-axis intensity than is achievable with a standard lamp. The light generated is focused to a narrow beam to achieve this effect.

### Package Dimensions

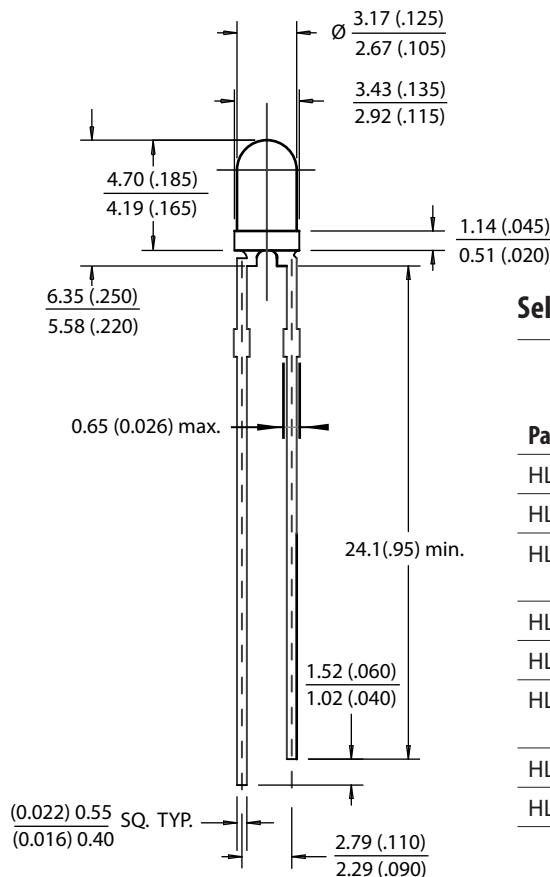

### Features

- High intensity
- Choice of 3 bright colors
  - High Efficiency Red
  - Yellow
  - High Performance Green
- Popular T-1 diameter package
- Selected minimum intensities
- Narrow viewing angle
- General purpose leads
- Reliable and rugged
- Available on tape and reel
- For more information, please refer to Tape and Reel Option data sheet

### Selection Guide

Part Number	Package Description	Color	Luminous Intensity I <sub>v</sub> (mcd) @ 10 mA	
			Min.	Max.
HLMP-1321	Tinted, Non-diffused	High Efficiency Red	8.6	–
HLMP-1321-G00xx			8.6	–
HLMP-1420	Microtinted, Non-diffused	Yellow	9.2	–
HLMP-1421	Tinted, Non-diffused		9.2	–
HLMP-1421-F00xx			9.2	–
HLMP-1520	Microtinted, Non-diffused	Green	6.7	–
HLMP-1521	Tinted, Non-diffused		6.7	–
HLMP-1521-E00xx			6.7	–

#### Notes:

1. All dimensions are in millimeters (inches).
2. An epoxy meniscus may extend about 1 mm (0.40") down the leads.
3. For PCB hole recommendations, see the Precautions section.

## Part Numbering System

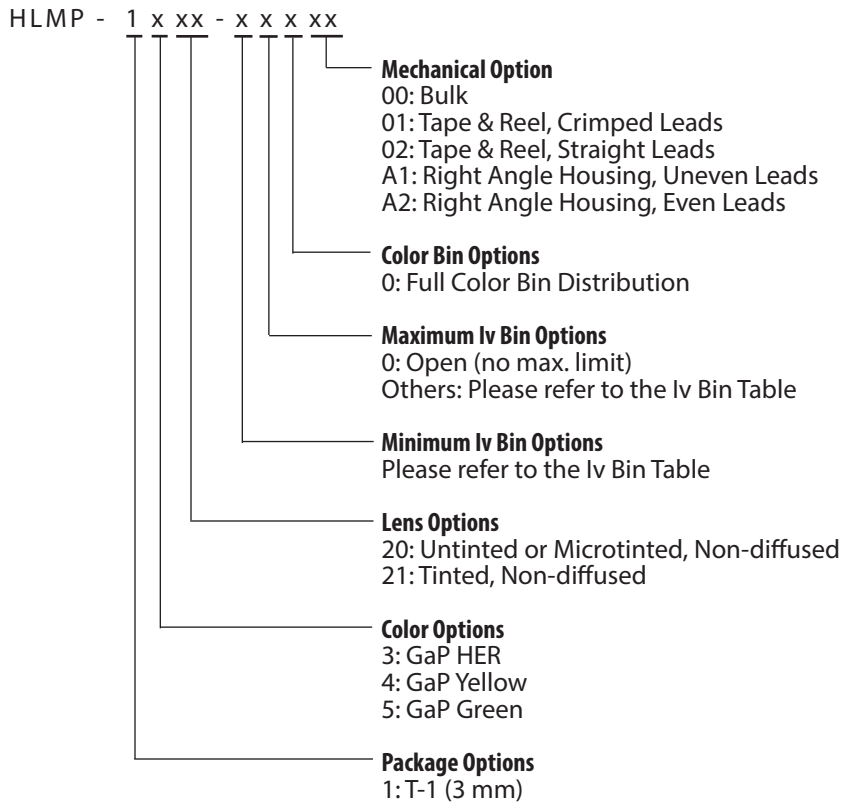

## Absolute Maximum Ratings at $T_A = 25^\circ\text{C}$

Parameter	Red	Yellow	Green	Units
Peak Forward Current	90	60	90	mA
Average Forward Current <sup>[1]</sup>	25	20	25	mA
DC Current <sup>[2]</sup>	30	20	30	mA
Power Dissipation <sup>[3]</sup>	135	85	135	mW
Reverse Voltage ( $I_R = 100 \mu\text{A}$ )	5	5	5	V
Transient Forward Current <sup>[4]</sup> (10 $\mu\text{sec}$ Pulse)	500	500	500	mA
LED Junction Temperature	110	110	110	$^\circ\text{C}$
Operating Temperature Range	-40 to +100	-40 to +100	-20 to +100	$^\circ\text{C}$
Storage Temperature Range	-40 to +100	-40 to +100	-40 to +100	

### Notes:

- See Figure 5 (Red), 10 (Yellow), or 15 (Green) to establish pulsed operating conditions.
- For Red and Green series derate linearly from  $50^\circ\text{C}$  at  $0.5 \text{ mA}/^\circ\text{C}$ . For Yellow series derate linearly from  $50^\circ\text{C}$  at  $0.2 \text{ mA}/^\circ\text{C}$ .
- For Red and Green series derate power linearly from  $25^\circ\text{C}$  at  $1.8 \text{ mW}/^\circ\text{C}$ . For Yellow series derate power linearly from  $50^\circ\text{C}$  at  $1.6 \text{ mW}/^\circ\text{C}$ .
- The transient peak current is the maximum non-recurring peak current that can be applied to the device without damaging the LED die and wirebond. It is not recommended that the device be operated at peak currents beyond the peak forward current listed in the Absolute Maximum Ratings.

## Electrical Characteristics at $T_A = 25^\circ\text{C}$

Symbol	Description	Device			Units	Test Conditions	
		HLMP-	Min.	Typ.			Max.
$I_V$	Luminous Intensity	1320	8.6	30	mcd	$I_F = 10\text{ mA}$ (Figure 3)	
		1321	8.6	30			
		1420	9.2	15	mcd	$I_F = 10\text{ mA}$ (Figure 8)	
		1421	9.2	15			
		1520	6.7	22	mcd	$I_F = 10\text{ mA}$ (Figure 3)	
1521	6.7	22					
$2\theta^{1/2}$	Including Angle Between Half Luminous Intensity Points	All		45	Deg.	$I_F = 10\text{ mA}$ See Note 1 (Figures 6, 11, 16, 21)	
$\lambda_{\text{PEAK}}$	Peak Wavelength	132x		635	nm	Measurement at Peak (Figure 1)	
		142X		583			
		152X		565			
$\Delta\lambda_{1/2}$	Spectral Line Halfwidth	132x		40	nm		
		142X		36			
		152X		28			
$\lambda_d$	Dominant Wavelength	132x		626	nm	See Note 2 (Figure 1)	
		142X		585			
		152X		569			
$\tau_s$	Speed of Response	132x		90	ns		
		142X		90			
		152X		500			
C	Capacitance	132x		11	pF	$V_F = 0; f = 1\text{ MHz}$	
		142X		15			
		152X		18			
$R\theta_{\text{J-PIN}}$	Thermal Resistance	All		290	$^\circ\text{C/W}$	Junction to Cathode Lead	
$V_F$	Forward Voltage	132x		1.9	2.4	V	$I_F = 10\text{ mA}$
		142X		2.0	2.4		
		152X		2.1	2.7		
$V_R$	Reverse Breakdown Voltage	All	5.0			V	$I_R = 100\text{ }\mu\text{A}$
$\eta_V$	Luminous Efficacy	132x		145		$\frac{\text{lumens}}{\text{watt}}$	See Note 3
		142X		500			
		152X		595			

### Notes:

- $\theta^{1/2}$  is the off-axis angle at which the luminous intensity is half the axial luminous intensity.
- The dominant wavelength,  $\lambda_d$ , is derived from the CIE chromaticity diagram and represents the single wavelength which defines the color of the device.
- Radiant intensity,  $I_e$ , in watts/steradian, may be found from the equation  $I_e = I_v/\eta_v$ , where  $I_v$  is the luminous intensity in candelas and  $\eta_v$  is the luminous efficacy in lumens/watt.



Figure 1. Relative intensity vs. wavelength.

### T-1 High Efficiency Red Non-Diffused

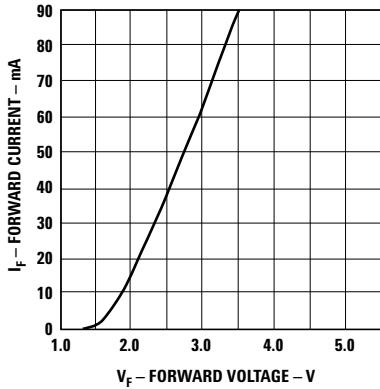

Figure 2. Forward current vs. forward voltage characteristics.

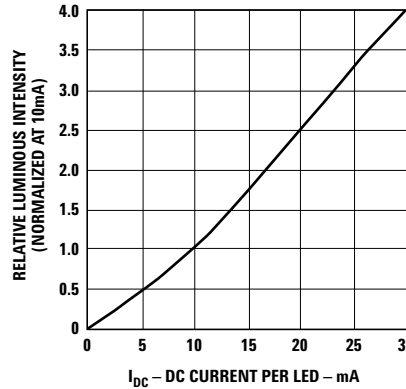

Figure 3. Relative luminous intensity vs. DC forward current.

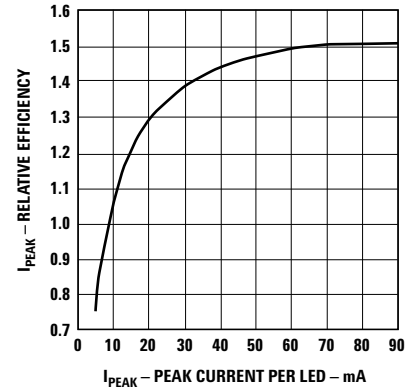

Figure 4. Relative efficiency (luminous intensity per unit current) vs. peak LED current.

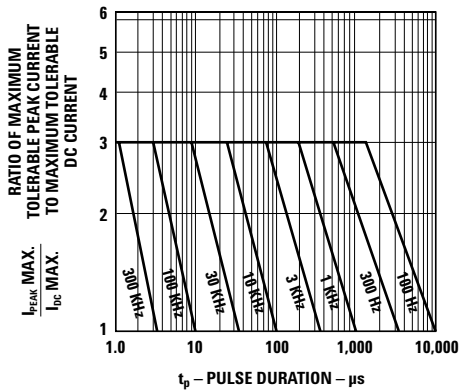

Figure 5. Maximum tolerable peak current vs. pulse duration. ( $I_{DC}$  MAX as per MAX ratings).

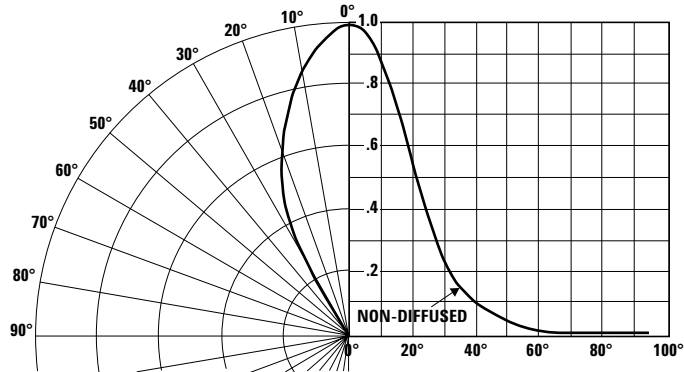

Figure 6. Relative luminous intensity vs. angular displacement.

# T-1 Yellow Non-Diffused

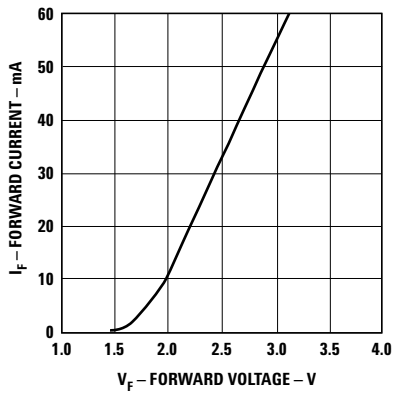

Figure 7. Forward current vs. forward voltage characteristics.

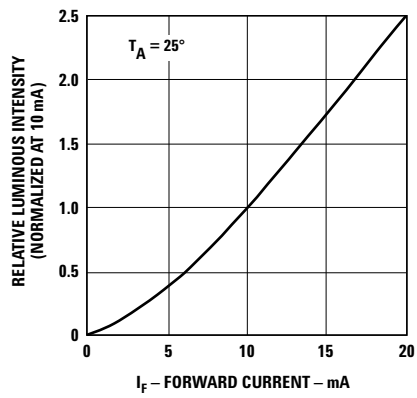

Figure 8. Relative luminous intensity vs. forward current.

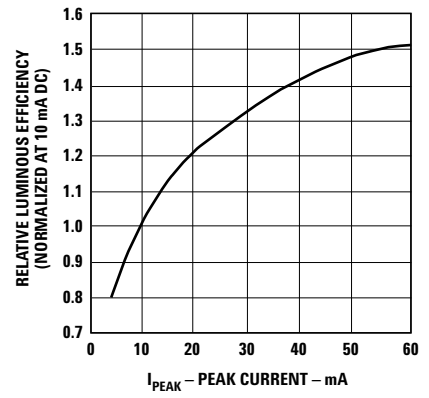

Figure 9. Relative efficiency (luminous intensity per unit current) vs. peak current.

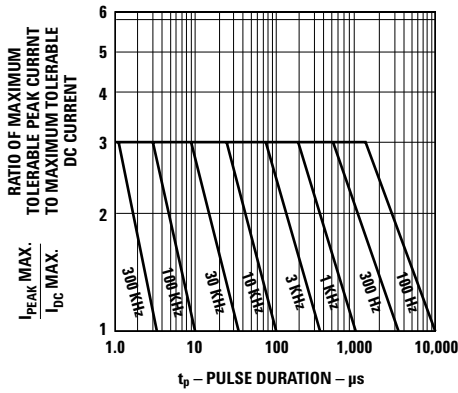

Figure 10. Maximum tolerable peak current vs. pulse duration. ( $I_{DC}$  MAX as per MAX ratings).

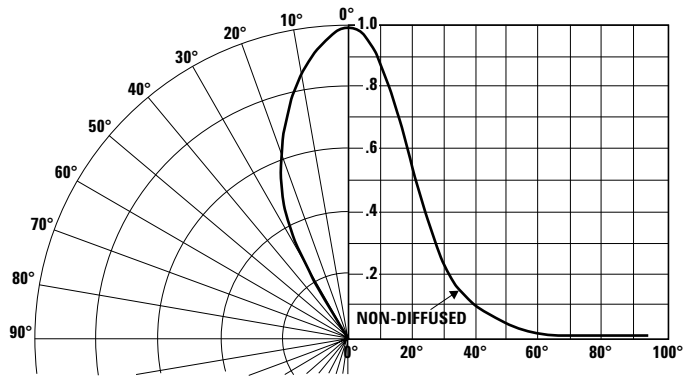

Figure 11. Relative luminous intensity vs. angular displacement.

# T-1 Green Non-Diffused

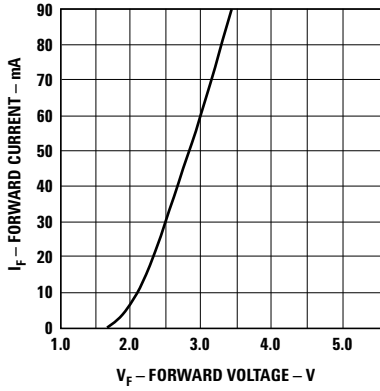

Figure 12. Forward current vs. forward voltage characteristics.

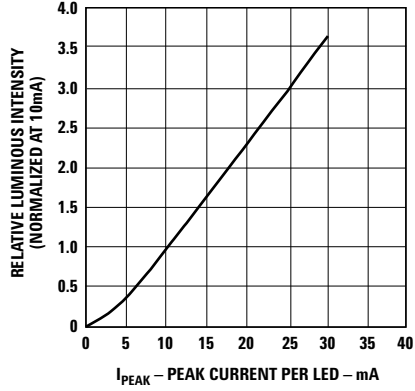

Figure 13. Relative luminous intensity vs. forward current.

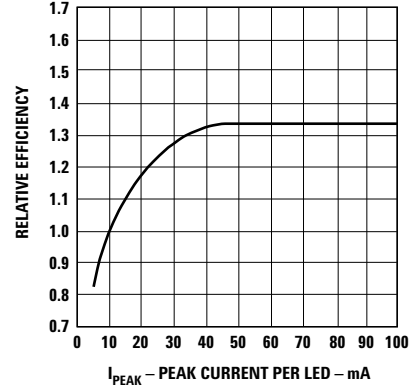

Figure 14. Relative efficiency (luminous intensity per unit current) vs. peak LED current.

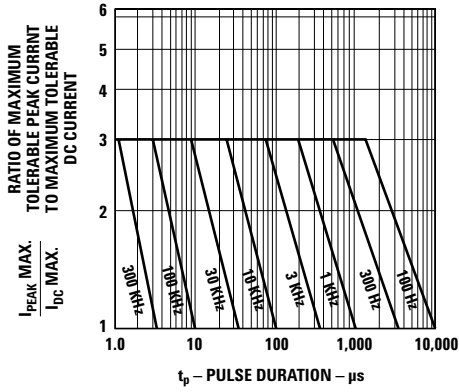

Figure 15. Maximum tolerable peak current vs. pulse duration. ( $I_{DCMAX}$  as per MAX ratings).

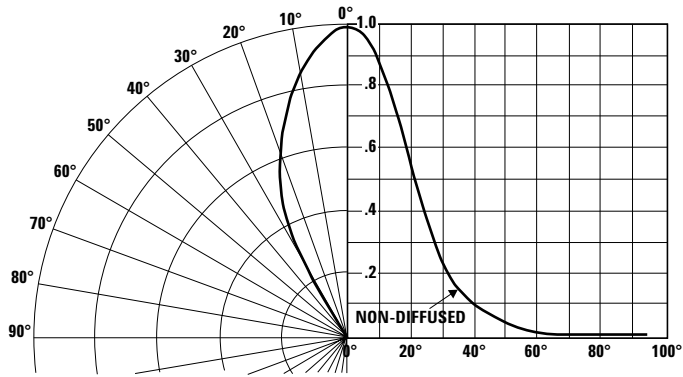

Figure 16. Relative luminous intensity vs. angular displacement.

### Intensity Bin Limits

Color	Bin	Intensity Range (mcd)	
		Min.	Max.
Red	G	9.7	15.5
	H	15.5	24.8
	I	24.8	39.6
	J	39.6	63.4
	K	63.4	101.5
	L	101.5	162.4
	M	162.4	234.6
	N	234.6	340.0
	O	340.0	540.0
	P	540.0	850.0
	Q	850.0	1200.0
	R	1200.0	1700.0
	S	1700.0	2400.0
	T	2400.0	3400.0
	U	3400.0	4900.0
	V	4900.0	7100.0
	W	7100.0	10200.0
	X	10200.0	14800.0
	Y	14800.0	21400.0
	Z	21400.0	30900.0
Yellow	F	10.3	16.6
	G	16.6	26.5
	H	26.5	42.3
	I	42.3	67.7
	J	67.7	108.2
	K	108.2	173.2
	L	173.2	250.0
	M	250.0	360.0
	N	360.0	510.0
	O	510.0	800.0
	P	800.0	1250.0
	Q	1250.0	1800.0
	R	1800.0	2900.0
	S	2900.0	4700.0
	T	4700.0	7200.0
	U	7200.0	11700.0
	V	11700.0	18000.0
W	18000.0	27000.0	

### Intensity Bin Limits

Color	Bin	Intensity Range (mcd)	
		Min.	Max.
Green	E	7.6	12.0
	F	12.0	19.1
	G	19.1	30.7
	H	30.7	49.1
	I	49.1	78.5
	J	78.5	125.7
	K	125.7	201.1
	L	201.1	289.0
	M	289.0	417.0
	N	417.0	680.0
	O	680.0	1100.0
	P	1100.0	1800.0
	Q	1800.0	2700.0
	R	2700.0	4300.0
	S	4300.0	6800.0
	T	6800.0	10800.0
	U	10800.0	16000.0
V	16000.0	25000.0	
W	25000.0	40000.0	

Maximum tolerance for each bin limit is  $\pm 18\%$ .

## Color Categories

Color	Category #	Lambda (nm)	
		Min.	Max.
Green	6	561.5	564.5
	5	564.5	567.5
	4	567.5	570.5
	3	570.5	573.5
	2	573.5	576.5
Yellow	1	582.0	584.5
	3	584.5	587.0
	2	587.0	589.5
	4	589.5	592.0
	5	592.0	593.0

Maximum tolerance for each bin limit is  $\pm 0.5$  nm.

## Mechanical Option Matrix

Mechanical Option Code	Definition
00	Bulk Packaging, minimum increment 500 pcs/bag
01	Tape & Reel, crimped leads, minimum increment 1800 pcs/bag
02	Tape & Reel, straight leads, minimum increment 1800 pcs/bag
A1	Right Angle Housing, uneven leads, minimum increment 500 pcs/bag
A2	Right Angle Housing, even leads, minimum increment 500 pcs/bag

**Note:**

All categories are established for classification of products. Products may not be available in all categories. Please contact your local Avago representative for further clarification/information.



## Precautions:

### Lead Forming

- The leads of an LED lamp may be preformed or cut to length prior to insertion and soldering into PC board.
- If lead forming is required before soldering, care must be taken to avoid any excessive mechanical stress induced to LED package. Otherwise, cut the leads of LED to length after soldering process at room temperature. The solder joint formed will absorb the mechanical stress of the lead cutting from traveling to the LED chip die attach and wirebond.
- It is recommended that tooling made to precisely form and cut the leads to length rather than rely upon hand operation.

### Soldering Conditions

- Care must be taken during PCB assembly and soldering process to prevent damage to LED component.
- The closest LED is allowed to solder on board is 1.59 mm below the body (encapsulant epoxy) for those parts without standoff.
- Recommended soldering conditions:

	Wave Soldering	Manual Solder Dipping
Pre-heat Temperature	105°C Max.	–
Pre-heat Time	30 sec Max.	–
Peak Temperature	250°C Max.	260°C Max.
Dwell Time	3 sec Max.	5 sec Max.

- Wave soldering parameter must be set and maintained according to recommended temperature and dwell time in the solder wave. Customer is advised to periodically check on the soldering profile to ensure the soldering profile used is always conforming to recommended soldering condition.
- If necessary, use fixture to hold the LED component in proper orientation with respect to the PCB during soldering process.
- Proper handling is imperative to avoid excessive thermal stresses to LED components when heated. Therefore, the soldered PCB must be allowed to cool to room temperature, 25°C, before handling.
- Special attention must be given to board fabrication, solder masking, surface plating and lead holes size and component orientation to assure solderability.
- Recommended PC board plated through hole sizes for LED component leads:

	LED Component Lead Size	Diagonal	Plated Through -Hole Diameter
Lead size (typ.)	0.45 × 0.45 mm (0.018 × 0.018 in.)	0.636 mm (0.025 in)	0.98 to 1.08 mm (0.039 to 0.043 in)
Dambar shear-off area (max.)	0.65 mm (0.026 in)	0.919 mm (0.036 in)	
Lead size (typ.)	0.50 × 0.50 mm (0.020 × 0.020 in.)	0.707 mm (0.028 in)	1.05 to 1.15 mm (0.041 to 0.045 in)
Dambar shear-off area (max.)	0.70 mm (0.028 in)	0.99 mm (0.039 in)	

**Note:** Refer to application note AN1027 for more information on soldering LED components.

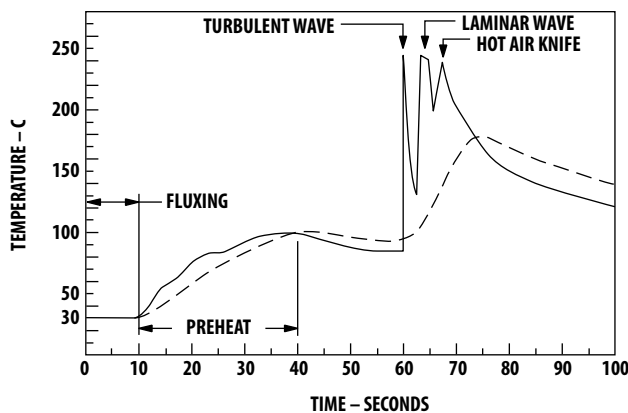

Figure 17. Recommended wave soldering profile.

— BOTTOM SIDE OF PC BOARD  
- - TOP SIDE OF PC BOARD

CONVEYOR SPEED = 1.83 M/MIN (6 FT/MIN)  
PREHEAT SETTING = 150C (100C PCB)  
SOLDER WAVE TEMPERATURE = 245C  
AIR KNIFE AIR TEMPERATURE = 390C  
AIR KNIFE DISTANCE = 1.91 mm (0.25 IN.)  
AIR KNIFE ANGLE = 40  
SOLDER: SN63; FLUX: RMA

**NOTE:** ALLOW FOR BOARDS TO BE SUFFICIENTLY COOLED BEFORE EXERTING MECHANICAL FORCE.

For product information and a complete list of distributors, please go to our website: [www.avagotech.com](http://www.avagotech.com)

Avago, Avago Technologies, and the A logo are trademarks of Avago Technologies in the United States and other countries. Data subject to change. Copyright © 2005-2013 Avago Technologies. All rights reserved. Obsoletes 5989-4253EN AV02-1068EN - July 24, 2013

**AVAGO**  
TECHNOLOGIES